



Product Guide

Sensors and Measuring Systems

- Displacement
- Dimension
- Distance
- Temperature
- Position
- Color



More Precision



Why choose Micro-Epsilon?

- More precision and innovation made in Germany
- Wide range of powerful and flexible products which are easy to integrate
- Consultation, development and production from a single source
- Hand in hand with our customers we create quality and solution competence in series & OEM
- Profound knowledge of industries & applications in automation, machine building and machine design

As a technology leader of precision sensors, Micro-Epsilon pursues the need to develop high precision sensors, measurement devices and systems. This need is the drive for continuous high performance in measurement technology. As well as sensors for displacement, distance, position, color and temperature, we also focus on 3D sensors.

Continuous development efforts, extensive know-how and a wide cooperation network enable us to develop high precision sensors. Further development of measuring techniques and technical innovations is our basis for the creation of sensor products that provide our customers with significant added value.

Contents

Sensors for displacement, distance, length and position	Page
Laser triangulation sensors	6 - 7
Confocal sensors for measuring displacement and thickness	8 - 9
White light interferometer for displacement and thickness measurements	10 - 11
Laser gauges and distance sensors	12 - 13
Capacitive displacement sensors	14 - 15
Eddy current displacement sensors	16 - 17
Inductive displacement sensors	18 - 19
Magneto-inductive distance sensors	20 - 21
Draw-wire displacement sensors	22 - 23
2D/3D sensor systems for dimensional measurement	Page
Laser profile sensors	24 - 25
Optical micrometers & fiber optic sensors	26 - 27
3D Measurement & surface inspection	28 - 29
Color sensors for surfaces and self-luminous objects	Page
Color sensors, color measuring system & LED Analyzers	30 - 31
Infrared temperature measurement	Page
IR temperature sensors	32 - 33
Application-specific solutions	Page
Special sensors & OEM sensors	34 - 35
Compact sensor systems	36 - 37
Measuring & inspection systems	38 - 39

> More Precision

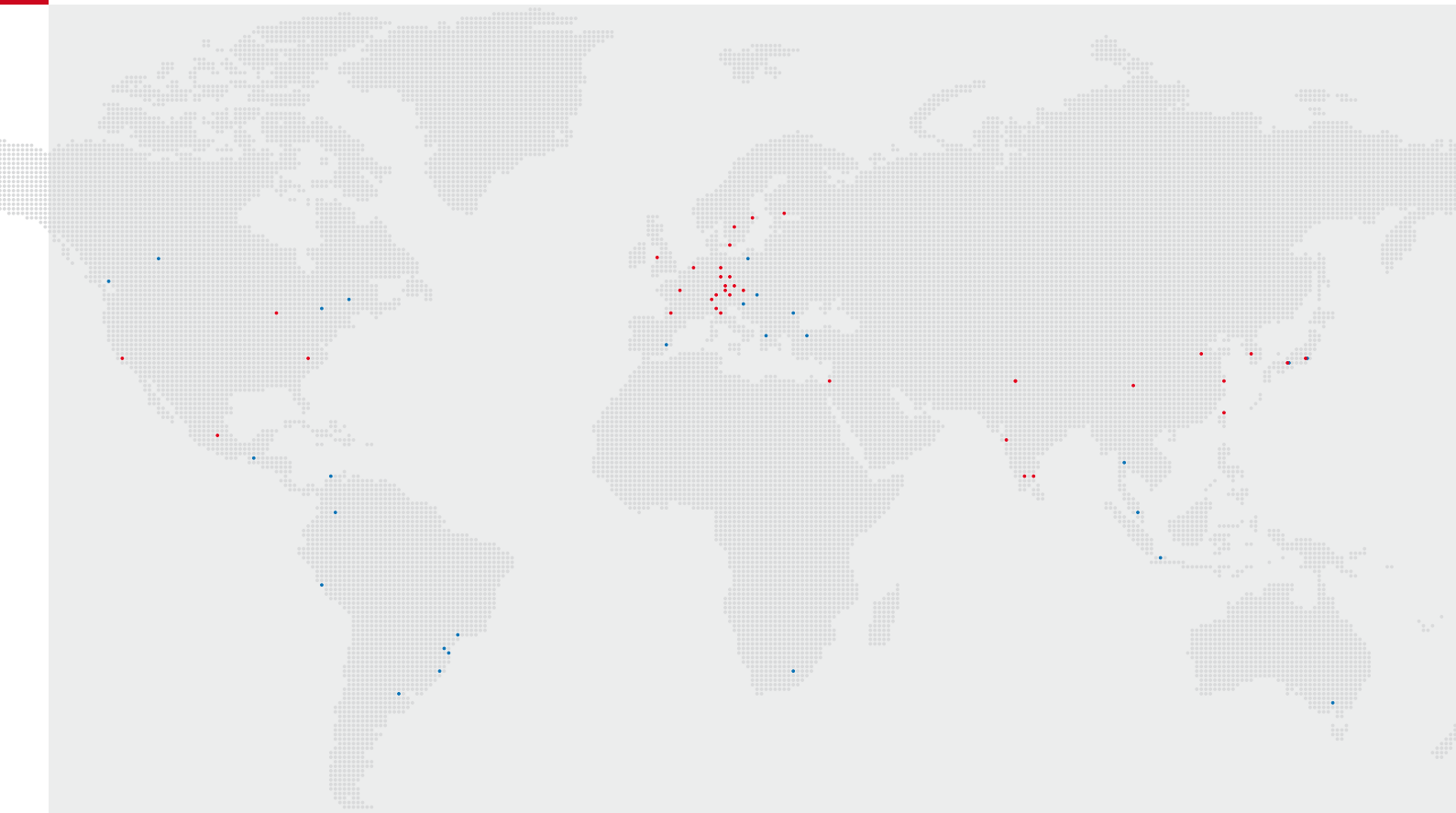

Sensors and measurement devices from Micro-Epsilon are used in numerous industries. Whether it is for quality assurance, applications in maintenance, process and machine monitoring, automation or R&D - sensors make a vital contribution to the improvement of products and processes. From global major groups to medium-sized companies and engineering service providers - sensors and solutions from Micro-Epsilon ensure reliable measurement results with the highest precision all over the world. From machine building and automated production lines in the food industry, to integrated OEM solutions - almost all industries benefit from sensor technologies.

Micro-Epsilon has the experience and the required resources to provide solutions starting from the basic idea through to series production, all from one source – and at a convincing price/performance ratio. A team of specialist development and application engineers implements concepts and designs according to customer-specific requirements. All project members are involved in development, prototype construction and series production.

Semiconductors & lenses

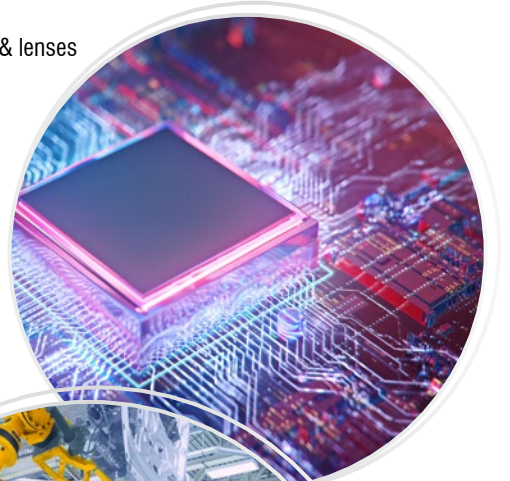

Advanced automation



Aerospace



Additive manufacturing



Automotive



Renewable energies



Laser triangulation sensors

for precise displacement distance measurements

optoNCDT

- Measurement of displacement, distance and position on numerous surfaces
- Detection of smallest parts due to point-shaped measurement
- Comprehensive product range with numerous measuring ranges
- High resolution and linearity
- Ideal for measurement tasks with high measuring rates
- Numerous interfaces, also for bus connection



optoNCDT sensors are designed for both measurement tasks in factory automation and integration into machines and systems. Despite their very compact dimensions, these robust laser sensors have a fully integrated controller. As a result, simple installation and wiring is possible in confined installation spaces or on a robot. Their high performance enables the sensors to provide precise measurement results at a high measuring rate.

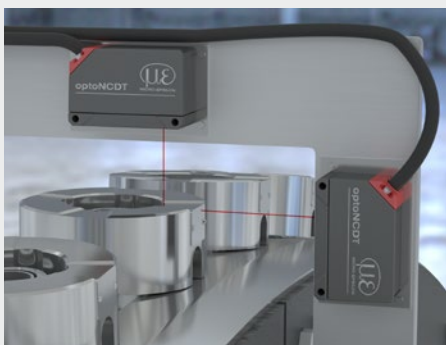

Dimension control of turned parts

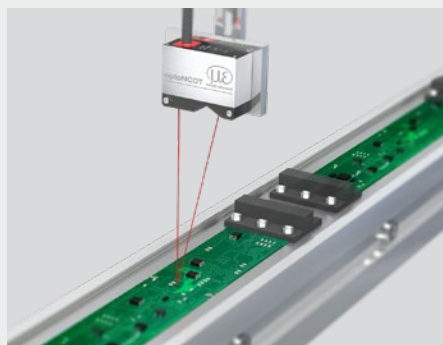

Use in PCB assembly

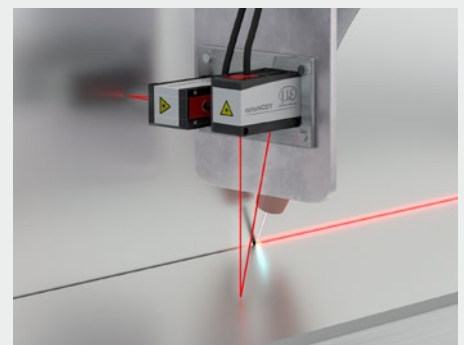

Distance control with laser welding



optoNCDT 1x20

Compact laser triangulation sensor for high speed, precision measurements

Measuring ranges (mm)	10 25 50 100 200 500
Linearity	≤ ±0.08 % FSO
Repeatability	from 0.5 μm
Measuring rate	2 kHz 4 kHz 8 kHz

New: optoNCDT 1220 with IO-Link



optoNCDT 1900

Innovative laser sensor for advanced automation

Measuring ranges (mm)	2 10 25 50 100 200 500
Linearity	< ±0.02 % FSO
Repeatability	from 0.1 μm
Measuring rate	10 kHz

Now with integrated EtherCAT, EtherNet/IP and PROFINET interfaces



optoNCDT 5500

The new class of high-performance laser sensors: ultra precise & ultra fast

Measuring ranges (mm)	10 25 50 100 200
Linearity	from 0.015 % FSO
Repeatability	from 0.008 μm
Measuring rate	up to 150 kHz



optoNCDT 1750-DR

Universal sensor with integrated controller for industrial applications

Measuring ranges (mm)	2 10 20
Linearity	≤ ±0.08% FSO
Repeatability	from 0.1 μm
Measuring rate	7.5 kHz



optoNCDT 1750BL/2300BL/2300-2DR

Laser sensor with Blue Laser Technology for metals and organic materials

Measuring ranges (mm)	2 5 20 50 200 500 750 1000
Linearity	≤ ±0.03% FSO
Resolution	0.0015 % FSO
Measuring rate	up to 49 kHz



optoNCDT 2300

Highly dynamic laser sensor in the 50 kHz class

Measuring ranges (mm)	2 5 10 20 50 100 200 300
Linearity	≤ ±0.02% FSO
Resolution	0.0015 % FSO
Measuring rate	49 kHz



optoNCDT 1420LL / 1900LL / 2300LL

Laser sensors for shiny metallic and structured surfaces

Measuring ranges (mm)	2 10 20 25 50
Linearity	≤ ±0.02% FSO
Resolution	0.0015 % FSO
Measuring rate	up to 49 kHz



optoNCDT 1750/1760/2310

Long-range sensors for large distances

Measuring ranges (mm)	10 20 40 50 200 500 750 1000
Linearity	≤ ±0.03% FSO
Resolution	0.005 % FSO
Measuring rate	up to 49 kHz

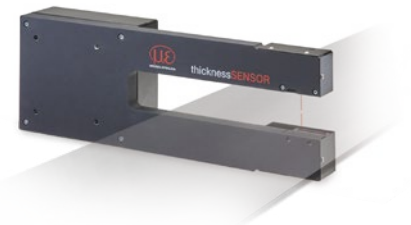

thicknessSENSOR

Sensor for non-contact thickness measurements of strip and plate materials

Measuring ranges (mm)	10 25
Linearity	±0.01 % FSO
Measuring rate	4 kHz
Measuring widths (mm)	200 400

Confocal chromatic sensors

for high precision displacement & thickness measurements

confocalDT

- Distance measurement with extremely high resolution and measuring rate
- Precise thickness measurement of transparent materials with up to 5 layers
- Extremely high resolution
- Suitable for all surfaces
- Extremely small, constant spot size
- Compact beam path
- Vacuum-suitable sensor design
- Numerous interfaces, also for bus connection



The confocalDT product range stands for the highest precision and dynamics in confocal chromatic measurement technology. The measuring system includes the worldwide fastest controller currently available, which in combination with the sensors enables high precision measurement results in displacement and distance measurement tasks, as well as thickness measurement of transparent objects. A large number of sensors and different interfaces can be used in versatile measurement tasks, e.g., in the semiconductor industry, glass industry, medical engineering and machine building.

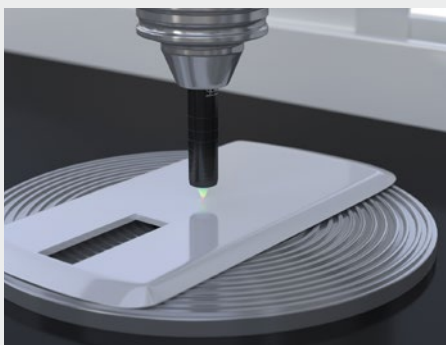

Roughness measurement and geometry inspection in coordinate measuring machines



Displacement and distance measurement in 3D printing

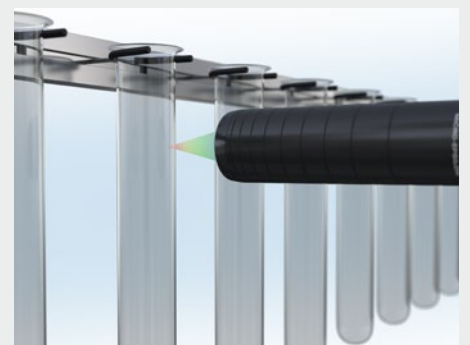

Wall thickness of medical glass containers



confocalDT 2411 / 2412 / 2416 / 2417

Compact controller for series applications
 Measuring rate up to 8 / 25 kHz
 Numerous interfaces for easy integration
 1- and 2-channel versions



confocalDT 2421 / 2422

Single and dual-channel controller with integrated light source for industrial applications and measuring rates up to 6.5 kHz

confocalDT 2465 / 2466

Light-intensive controller with measuring rate up to 30 kHz



**PROFI
NET**
EtherCAT
EtherNet/IP

confocalDT 2410/2415

Compact sensors with integrated controller

Measuring ranges (mm)	1 3 6 10
Linearity	up to $\pm 0,025$ % FSO
Measuring rate	up to 8 kHz / 25 kHz



IFS2402

Miniature sensors (gradient index lens) for the inspection of smallest inner bodies

Measuring ranges (mm)	0,5 1,5 4
-----------------------	---------------

Available with axial / radial beam path



IFS2403

Confocal hybrid sensors with narrow gradient index lens and relay lens

Measuring ranges (mm)	0.4 1.5 4 10
Resolution	0.0015 % FSO

Available with axial / radial beam path



IFS2404

Confocal chromatic sensors for high precision applications in restricted spaces

Measuring ranges (mm)	1 2 3 6 18
Resolution (μ m)	0.012

Available with axial / radial beam path



IFS2405

Standard sensors for precise distance and thickness measurements

Measuring ranges (mm)	0.3 1 3 6 10 28 30
-----------------------	--------------------------------

Large offset distance and tilt angle



IFS2406

Confocal chromatic compact sensors for displacement & thickness measurements

Measuring ranges (mm)	2.5 3 10
-----------------------	--------------

Available with axial / radial beam path



IFS2407

Confocal sensors for precise displacement, thickness & roughness measurements

Measuring ranges (mm)	0,1 0,3 0,8 1,5 2 3 4 6
-----------------------	---------------------------------------

Small measurement spot and large tilt angle

Available with axial / radial beam path

High-temperature version up to 200 °C

High-precision white light interferometer

for non-contact distance and thickness measurements

interferoMETER

- Absolute distance measurement and multi-peak distance measurement
- Distance-independent thickness measurement & multi-layer thickness measurement
- Best-in-Class: resolution < 30 picometers and outstanding linearity
- High signal stability due to new evaluation algorithms and active temperature compensation
- Simple parameter set up via web interface
- Numerous interfaces, also for bus connection

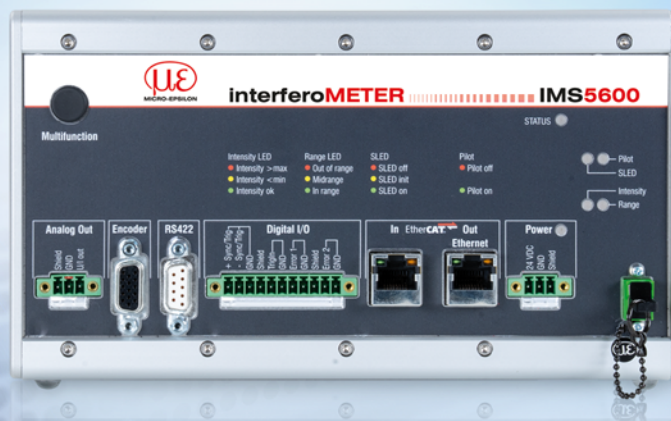

The innovative white light interferometers from Micro-Epsilon set a benchmark in high-precision distance and thickness measurements. These sensors enable stable measurement results with sub-nanometer resolution offering a comparatively large measuring range and offset distance. The robust and compact design of the sensors and controllers makes the interferometers ideal for integration into automated production systems and machines.

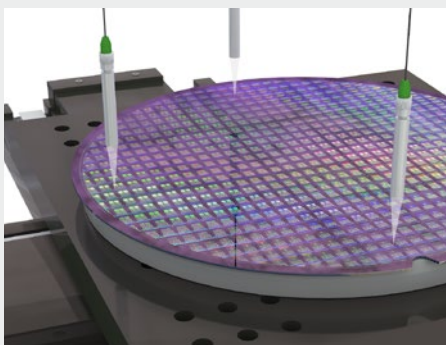

Inspection of wafer tilt angle

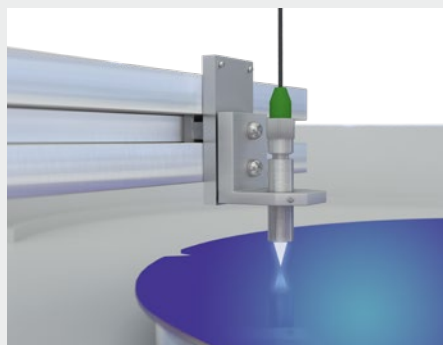

Thickness measurement of wafers



Thickness measurement of flat glass



interferoMETER 5400-DS

White light interferometer for absolute distance measurement with nanometer accuracy

Measuring range	2.1 mm
Linearity	< ±50 nm
Resolution	< 1 nm
Measuring rate	up to 6 kHz
Multi-peak distance measurement (thickness calculation)	



interferoMETER 5400-TH

White light interferometer for stable thickness measurement with submicron accuracy

Working distance	45 mm ±3.5 mm 70 mm ±2.1 mm
Linearity	< ±100 nm
Resolution	< 1 nm
Measuring rate	up to 6 kHz
Multi-peak thickness measurement	



interferoMETER 5600-DS

White light interferometer for absolute distance measurement with subnanometer accuracy

Measuring range	2.1 mm
Linearity	< ±10 nm
Resolution	< 30 pm
Measuring rate	up to 6 kHz
Multi-peak distance measurement (thickness calculation)	



interferoMETER 5420

Interferometer for high-precision wafer thickness measurement

- Resolution up to 1 nm
- Light spot diameter of just 20 µm
- Measurement of undoped and doped wafers (p+/p++, 5 Ω:cm)
- Intuitive operation via web interface
- Single and multi-layer thickness measurements



interferoMETER 5200

White light interferometer for thin layers

- Nanometer-precise layer thickness measurement of transparent materials
- Resolution < 1 nm
- Measuring rate up to 24 kHz for high speed measurements
- Single and multi-layer thickness measurements

Analog
RS422
Ethernet
EtherCAT®
PROFINET®
EtherNet/IP

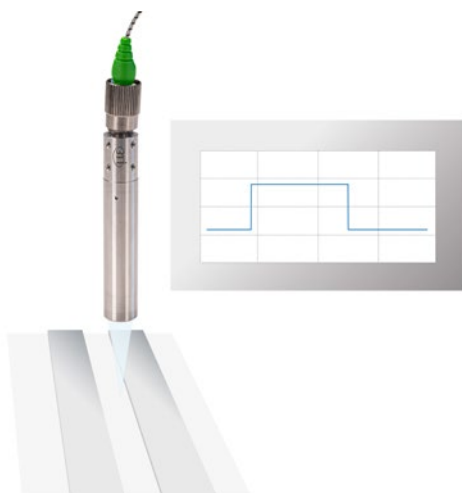

Absolute measurement of step profiles

Unlike interferometers based on relative measurements, the IMS-DS also enables the measurement of step profiles. Thanks to the absolute measurement, the scanning is performed with high signal stability and precision. When measuring on moving objects, the differences in height of heels, steps and depressions can thus be reliably detected.

Laser distance sensors

for the precise measurement of large distances

optoNCDT ILR

- Precise measurement of displacement, distance & position on different surfaces
- Very large measuring range
- High repeatability
- Fast response time
- Excellent price/performance ratio
- Open interfaces



Analog

RS422

PROFI
NET

EtherNet/IP

IO-Link
inside

Optoelectronic optoNCDT ILR sensors are designed for non-contact distance and displacement measurements with large measuring ranges. Depending on the application and the required measuring range, the sensors detect diffuse reflecting surfaces or special reflector plates. Thanks to their robust design, optoNCDT ILR sensors are suitable for measurement tasks indoors and also outdoors.

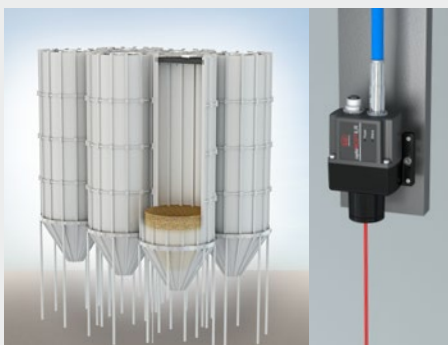

Continuous fill level measurement

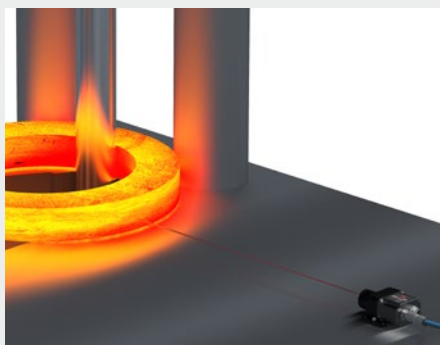

Diameter monitoring on seamless rolled rings



Acquisition of coil diameters



optoNCDT ILR 104x
Compact laser distance sensors

Measuring range	no reflector 10 m with reflector 150 m
Linearity	±20 mm
Repeatability	< 3 mm
Response time	3 ms



optoNCDT ILR 1171-125
Fast sensors for outdoor applications

Measuring range	no reflector 125 m with reflector 270 m
Linearity	< ±60 mm
Repeatability	< 25 mm
Measuring rate	up to 40 kHz



optoNCDT ILR 3800
High-performance laser distance sensors

Measuring range	no reflector 100 m with reflector 150 m
Linearity	< ±1 mm
Repeatability	< 300 μm
Measuring rate	20 Hz

Measurement is performed directly onto the target

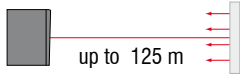

Measurement against a reflector which is installed on the target



		ILR 104x	ILR 1171	ILR 3800
Measuring range in gauging mode (without reflector)	10 m	•		
	100 m			•
	125 m		•	
Measuring range with reflector	150 m	•		•
	270 m		•	

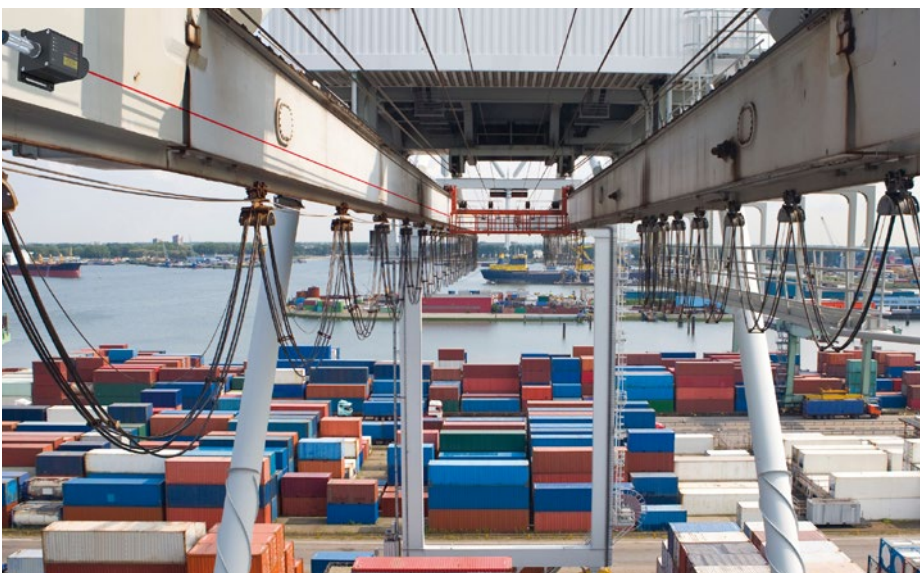

optoNCDT ILR sensors are particularly suitable for filling level measurement, safety applications, height measurement of lifting systems, overhead conveyors, crane systems and for positioning lifts.



Capacitive sensors

for non-contact displacement & distance measurements

capaNCDT

- Non-contact measurement of displacement, distance and thickness as well as on electrical conductors and insulators
- Resolution down to the nanometer range
- Temperature stability over a large temperature range
- World's most modern product portfolio for a wide range of laboratory and industrial applications
- Numerous interfaces, also for bus connection

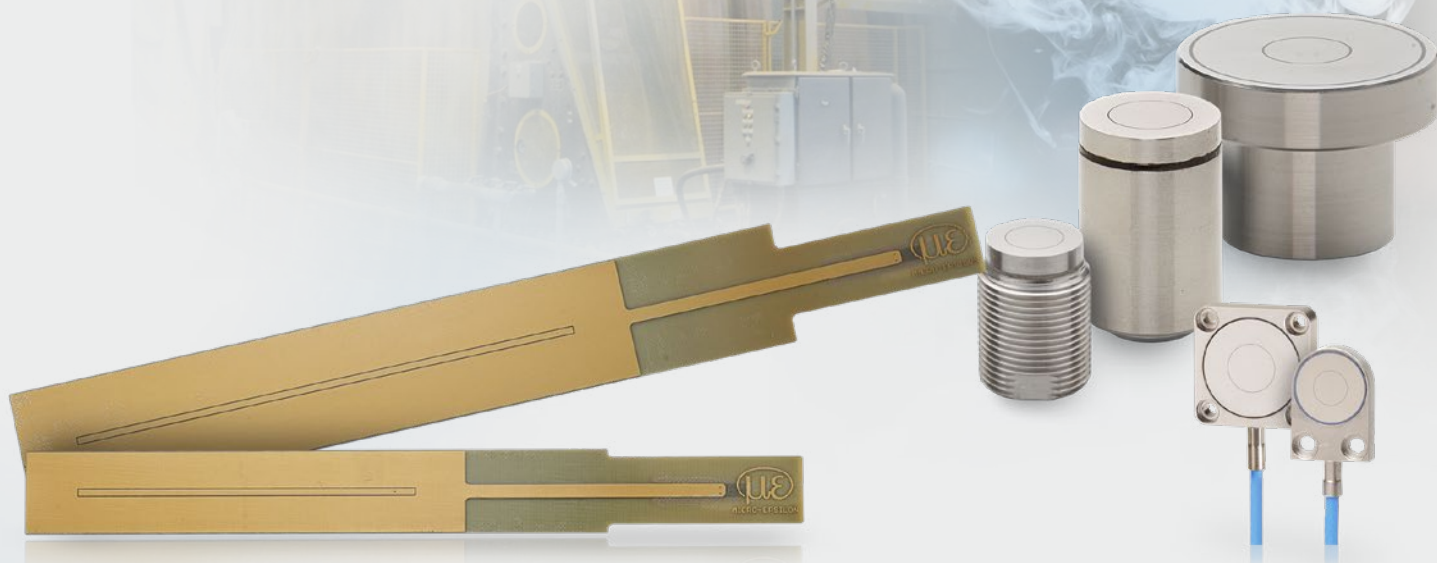

Capacitive sensors are designed for non-contact displacement and distance measurements with the highest precision and are used for measurement tasks in the laboratory as well as in industrial applications. Their special sensor design, triaxial sensor cables and innovative controller technology result in a perfectly matched measuring system. For this reason, capacitive sensors from Micro-Epsilon stand for the highest precision and signal stability. Even in industrial applications, capacitive sensors achieve resolutions in the submicrometer range.

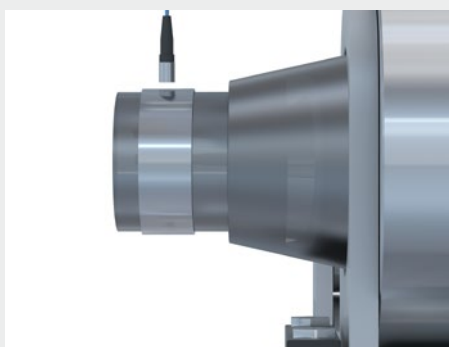

Measuring the bearing gap in roll drives

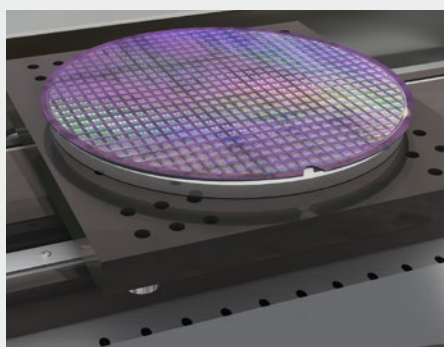

Positioning of precision stages

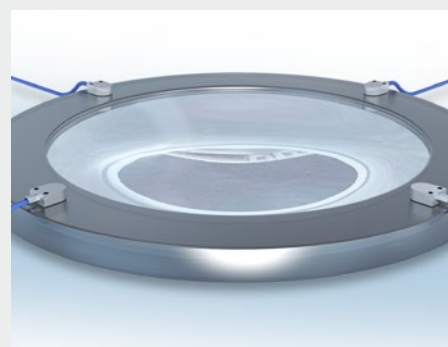

Checking the tilt angle of lens carriers



capaNCDT 6110
Compact single-channel system

Measuring ranges (mm)	0.05 0.2 0.5 0.8 1 2 3 5 10
Linearity	$\leq \pm 0.05\%$ FSO
Resolution	0.01 % FSO
Frequency response	up to 20 kHz (-3dB)



capaNCDT 61x0/IP
Measuring system for industrial applications

Measuring ranges (mm)	0.5 1 1.25 2 3 4 6
Linearity	$\leq \pm 0.1\%$ FSO
Resolution	0.01 % FSO
Frequency response	1 kHz (-3dB)



capaNCDT 6200
Modular multi-channel system

Measuring ranges (mm)	0.05 0.2 0.5 0.8 1 2 3 5 10
Linearity	$\leq \pm 0.025\%$ FSO
Resolution	0.0005 % FSO
Frequency response	up to 20 kHz (-3dB)



capaNCDT 6500
Modular multi-channel system

Measuring ranges (mm)	0.05 0.2 0.5 0.8 1 2 3 5 10
Linearity	$\leq \pm 0.025\%$ FSO
Resolution	0.000075 % FSO
Frequency response	8.5 kHz (-3dB)



capaNCDT 61x4
Active sensor system, ideal for long signal transmission paths up to 15 m
Sensor cable for use on drag chains and robots
Easy integration due to flexible cable routing
Robust sensor design



capaNCDT DTV
Measuring the Disc Thickness Variation of brake discs
Multi-channel controller for multi-track thickness measurements
High dynamics up to 20 kHz
Robust sensor design for long-life operation
Comprehensive software package for ease of use and real-time evaluation of measurement results
Analog interfaces, Ethernet, EtherCAT



capaNCDT 6228
Capacitive measuring system for high temperature application

Measuring ranges (mm)	1 2 5 10
Linearity	from 0,5 μ m
Resolution	up to 0,01 % FSO
Frequency response	up to 1 kHz
Wide temperature range:	-50 ... +800 °C

Adaption of sensors to OEM serial applications

- Shape & size
- Sensor material
- Cable
- Vacuum suitability
- Cryogenic or high temperatures
- Integrated controller with sensor for OEM design

Other capacitive sensors for special measurement tasks on page 35



Inductive sensors (eddy current)

for high precision displacement & distance measurements

eddyNCDT

- Non-contact and wear-free
- High resolution and linearity
- Stable measurement signals
- High dynamics
- Excellent temperature range and temperature stability
- For industrial applications
- Numerous interfaces, also for fieldbus connection



For many years, Micro-Epsilon has been a pioneer in displacement measurement using eddy current technology. eddyNCDT displacement sensors are designed for non-contact measurement of displacement, distance, position, oscillation, vibrations etc. Considered as extremely robust and precise, eddy current sensors from Micro-Epsilon are preferably used in industrial environments. eddyNCDT sensors are based on the eddy current principle and are used for measurements on metallic targets. They enable non-contact and wear-free measurements without exerting any forces onto the measuring object. The insensitivity to, e.g., oil, dirt, water or electromagnetic interference fields makes eddyNCDT sensors ideal for measurement tasks in which precise measurements are required despite harsh industrial environments.

Extreme temperature stability

Eddy current sensors from Micro-Epsilon can be used in a wide temperature range, some models from $-50\text{ }^{\circ}\text{C}$ to $+350\text{ }^{\circ}\text{C}$. Their wide temperature range and insensitivity to dirt or dust enable a variety of applications in industrial environments. Active temperature compensation ensures the highest signal stability with fluctuating ambient temperatures.

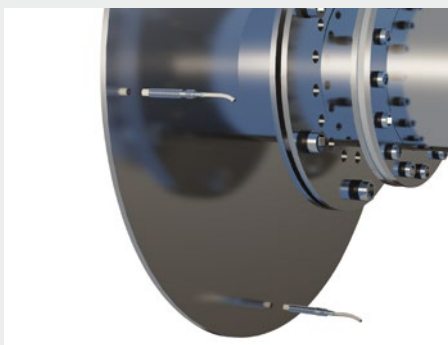

Measuring the radial runout of clutch discs

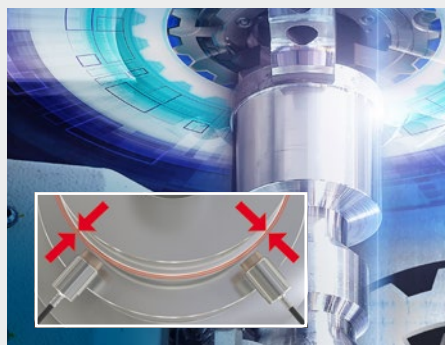

Measuring the spindle runout

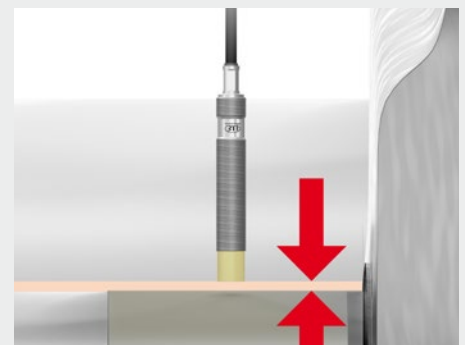

Monitoring the oil gap of drive shafts



eddyNCDT 3001

Compact eddy current sensor with integrated controller

Measuring ranges (mm)	2 4 6 8
Linearity	< ±0.7 % FSO
Resolution	0.1 % FSO
Frequency response	5 kHz



eddyNCDT 3005

Miniature eddy current measuring system ideal for integration into plant and machinery

Measuring ranges (mm)	1 2 3 6
Linearity	< ±0.25 % FSO
Resolution	0.05 % FSO
Frequency response	5 kHz (-3dB)



eddyNCDT 3060/3070

A new performance class in inductive displacement measurements

Measuring ranges (mm)	0.4 0.8 1 2 3 4 6 8
Linearity	< ±0.1 % FSO
Resolution	0.002 % FSO
Frequency response	20 kHz (-3dB)



eddyNCDT 3020

High-performance eddy current measuring system for industrial series applications

Measuring ranges (mm)	1 - 80
Linearity	< ±0.2 % FSO
Resolution	0.002 % FSO
Frequency response	up to 5 kHz

Ideal for use at high temperatures: controller up to 105 °C / sensor up to 200 °C



Largest sensor range worldwide

Our long-term technology leadership in the field of eddy current sensor technology is reflected by the range of products - more than 400 sensors are available in different designs for different applications. The range includes miniature sensors which achieve high precision measurement results with the smallest possible dimensions.

For special requirements that are not met by standard models, the standard sensors can be modified accordingly. Cost-effective implementation can already be achieved with medium-sized quantities. For special applications where large quantities are required, Micro-Epsilon develops sensors that are precisely tailored to the customer's requirements.

Adaption of sensors for small and large series

- Shape & size
- Sensor material
- Cable
- Connector
- Vacuum suitability
- Sensor with integrated controller

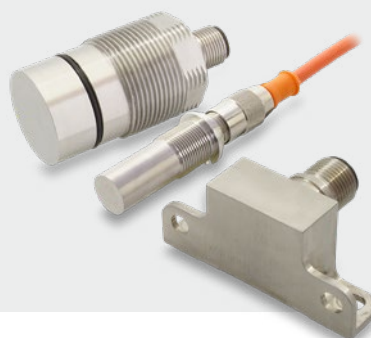

Other eddy current sensors for special measurement tasks on page 35

Linear inductive displacement sensors

for industrial measurement tasks

induSENSOR

- More than 250 different models with measuring ranges from 1 to 630 mm
- Integrated or separate controller
- High accuracy
- Extreme stability and durability
- Different designs with plunger, tube or measuring ring
- Analog output, digital interfaces and fieldbus connection
- Ideal for customer-specific designs and serial applications



For decades, Micro-Epsilon has been renowned for its inductive displacement sensors and gauges and has extended the range of proven measurement techniques such as, e.g., LVDT by further innovative developments. induSENSOR displacement sensors from Micro-Epsilon are used extensively in applications for automated processes, quality assurance, test rigs, hydraulics, pneumatic cylinders, and building monitoring. Typical measurement tasks require a long service life and reliability.

The induSENSOR models stand out due to their robustness and reliability under harsh conditions. As they provide high signal quality, temperature stability, resistance to shocks and vibrations as well as insensitivity to dirt and humidity, these sensors are the preferred choice for industrial measurement tasks.

induSENSOR systems are universally applicable and have been tried and tested in various industries. When several measuring points are required, the 2-channel controllers or multi-channel systems are used that are equipped with digital interfaces and, in addition, enable integration into fieldbus environments.



Stress and bending tests for material experiments

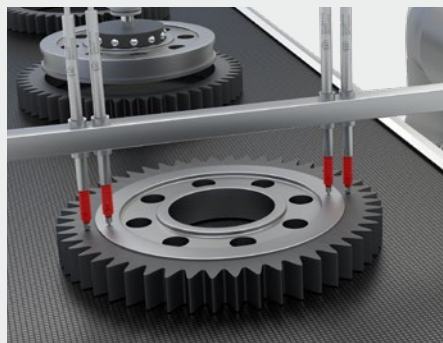

Checking the offset of gears



Lift height measurement in pneumatic cylinders



induSENSOR DTD series

Sensor system with compact cable controller

Measuring ranges (mm)	±1 3 5 10
Linearity	≤ ±0.05 % FSO
Frequency response	up to 300 Hz (-3dB)
Target	Plunger with spring



induSENSOR LVDT series

Gauging sensor with external controller

Measuring ranges (mm)	±1 3 5 10
Linearity	±0.3 % FSO
Frequency response	300 Hz (-3dB)
Target	Plunger with spring



induSENSOR LVDT series

Displacement sensors with external controller

Measuring ranges (mm)	±1 3 5 10 15 25
Linearity	±0.15 % FSO
Frequency response	300 Hz (-3dB)
Target	Plunger



induSENSOR LDR series

Linear displacement sensors with external controller for high temperatures up to 160 °C

Measuring ranges (mm)	10 25 50
Linearity	±0.3 % FSO
Frequency response	300 Hz (-3dB)
Target	Plunger



induSENSOR EDS series

Displacement sensors with integral controller

Measuring ranges (mm)	75 100 160 200 250 300 370 400 500 630
Linearity	±0.3 % FSO
Resolution	0.05 % FSO
Frequency response	150 Hz (-3dB)
Target	Measuring tube
Pressure resistance	450 bar



Miniature sensor controller

for inductive displacement sensors

The MSC controllers are designed to be operated with LVDT and LDR measuring gauges and displacement sensors. Due to the robust and compact aluminum housing, the controllers are ideal for industrial measurement tasks. A wide variety of compatible, inductive displacement sensors and gauges combined with an optimized price/performance ratio opens up numerous fields of applications in automation technology and machine building.

For special requirements that are not met by standard models, the standard sensors can be modified accordingly. Cost-effective implementation can already be achieved with medium-sized quantities. For special applications where large quantities are required, Micro-Epsilon develops sensors that are precisely tailored to the customer's requirements.

Adapted to ambient conditions

Depending on the location of use, environment, and application, different influences prevail to which the sensors are adapted.

- Ambient temperature
- Pressure
- Interference fields
- Dirt, dust, and moisture
- Vibration, shock
- Seawater, IP69K



Magneto-inductive distance sensors

for industrial measurement tasks

mainSENSOR

- Ideal alternative to inductive sensors and proximity sensors
- Linear output signal, high basic sensitivity and temperature stability
- High dynamics
- Measuring range can be adjusted via magnets
- Ideal for customer-specific designs and serial applications



mainSENSOR distance sensors use an innovative measuring principle, which combines the advantages of both inductive and magnetic sensors. Measuring the distance to a magnet which is attached to the measuring object, the sensor outputs a continuous, linear output signal. By using magnets of different strengths, measuring ranges between 20 mm and 55 mm can be achieved. In order to adapt the measuring range, you only have to change the magnet.

Magneto-inductive sensors are frequently used as an alternative to inductive sensors and proximity sensors in process automation, the packaging industry and in machine monitoring. Their sensor design brings numerous application possibilities, especially for OEM series applications. The sensor is available as simple PCB, in a plastic housing or in housings made from stainless steel, which are resistant to many chemicals as well as oil or dirt.



Load measurement in washing machines

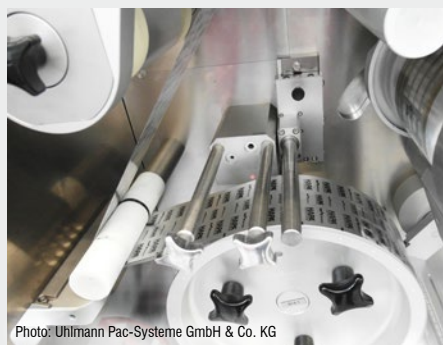

Photo: Uhlmann Pac-Systeme GmbH & Co. KG

Foreign body detection in blister packs



Photo: SIG Combibloc Group AG

Valve lift measurement in the food industry



MDS-45-M18-SA

Measuring range	20 - 55 mm*
Output	2 - 10 V
Linearity	< ±3 % FSO
Resolution	0.05 % FSO
Pressure resistance	up to 400 bar (front)
Frequency response	3 kHz (-3dB)



MDS-45-M12

Measuring range	20 - 55 mm*
Output	2 - 10 V
Linearity	< ±3 % FSO
Resolution	0.05 % FSO
Axial cable output or connector	
Frequency response	3 kHz (-3dB)



MDS-45-M30-SA

Measuring range	20 - 55 mm*
Output	2 - 10V / 4 - 20 mA
Linearity	< ±3 % FSO
Resolution	0.05 % FSO
Pressure resistance	50 bar (front)
Frequency response	1 kHz (-3dB)



MDS-35-M12-HT

Measuring range	20 - 55 mm*
Output	2 V ±0.4 V ... 9.6 V ±0.4 V
Linearity	< ±5 % FSO
Resolution	< 0.05 % FSO
Axial cable output or connector	
Frequency response	5 kHz (-3dB)
Temperature range	up to 120 °C



MDS-40-MK

Measuring range	approx. 40 mm*
Output	different kinds
Linearity	< ±3 ... < ±5 % FSO
Resolution	0.05 % FSO
Number of pieces	from 1 or 10 pcs. / freely configurable from 200 pcs.

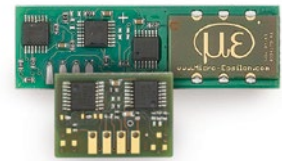

MDS-40-LP

Measuring range	approx. 40 mm*
Output	square
Linearity	< ±9 % FSO
Resolution	0.05 % FSO
Number of pieces	2,000 or 5,000 pcs./year

*depends on the magnet



Accessories

Measuring ranges of magnets: 20 mm, 27 mm, 35 mm, 45 mm, 55 mm
Power and output cables with M8x1 connector in different types

Flexible sensor design for OEM applications

Due to the flexible sensor design and the significant advantages of this physical measuring principle, various possibilities are available for adjusting the sensor to specific high volume applications. In OEM projects, the requirements of certain applications can be met at a very competitive price level.

- Improved dynamics
- Different shapes and materials for the housing
- Various output signals
- Special features such as pressure resistance, integrated cables, etc.

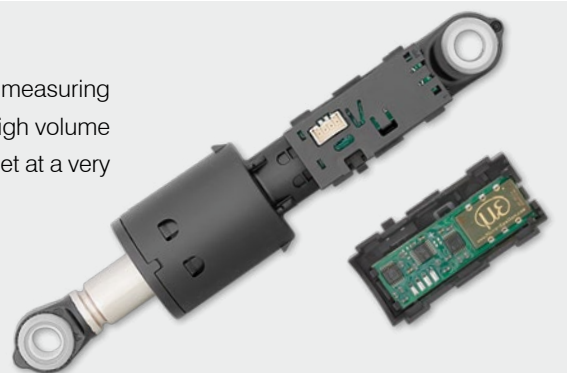

Draw-wire sensors

for displacement, position and length

wireSENSOR

- Measuring displacement, distance and position up to 50,000 mm
- Compact sensor housing combined with a large measuring range
- Ideal for difficult-to-access positions
- Easy, fast and flexible mounting
- Robust design, also for outdoors
- Excellent price/performance ratio
- Ideal for customized OEM series



Draw-wire sensors from Micro-Epsilon enable the measurement of long displacements with a small sensor size. Draw-wire displacement sensors measure the linear movement of a component using a wire made from highly flexible stainless steel strands, which is wound onto a drum by means of a long-life spring motor. The wire is attached directly to the measuring object and can also be guided over deflection pulleys to reach installation spaces that are difficult to access. The winding drum is axially coupled with a multi-turn potentiometer, an incremental encoder, or an absolute encoder.

Different sensor designs range from easy low-cost models to extremely robust designs for industrial applications. wireSENSOR models stand out due to their optimized ratio between measuring range and size, easy installation and handling. Their robust sensor design enables reliable measurements even in challenging ambient conditions.



Synchronization monitoring with draw-wire sensors in telescopic platforms



Measuring the deformation of rotor blades for wind turbines



Measuring the lift height in forklift trucks



wireSENSOR
MK30/MK46/MK77/MK60 / MK88/MK120
 OEM miniature sensors with plastic housing

Measuring ranges (mm)	50 150 250 500 750
	1000 1250 1500 2100 2300 2400 3000 3500 5000 7500
Analog outputs	Potentiometer, voltage, current
Digital output	Encoder



wireSENSOR MT
 Miniature draw-wire sensors with aluminum housing

Measuring ranges (mm)	40 80 130
Analog output	Potentiometer
Miniature sensor size	



wireSENSOR MPM/MP/MPW
 Robust miniature sensors with aluminum housing

Measuring ranges (mm)	50 100 150 250 300 500 1000
Analog output	Potentiometer
Option with wire acceleration	up to 100 g
Option with protection class	IP67



wireSENSOR P60/P96/ P115
 Industrial sensors with aluminum housing

Measuring ranges (mm)	100 150 300 500 750 1000 1500 2000 2500 3000 4000 5000 7500 10,000 15,000
Analog outputs	Potentiometer, voltage, current
Digital outputs	HTL, TTL, SSI, PB, CO



wireSENSOR P200
 Long-range industrial sensors with aluminum housing

Measuring ranges (mm)	30,000 40,000 50,000
Digital outputs	HTL, TTL, SSI, PB, CO



wireSENSOR K
 Draw-wire sensors for integration & OEM

Measuring ranges (mm)	1500 2500 3500 5000 8000 12000
Analog outputs	Potentiometer, voltage, current
Digital outputs	CO
Protection class	IP67 / IP69K

wireSENSOR mechanics

wireSENSOR mechanics are designed in such a way that they ensure easy mounting of an incremental or absolute encoder. Therefore, the user can individually choose the interface, resolution and connection type. Due to the robust housing, the draw-wire mechanisms are ideal for industrial use.

WDS mechanics

Draw-wire sensor mechanics for encoder installation

Measuring ranges (mm)	1,500 3,000 5,000 7,500 10,000 15,000 30,000 40,000 50,000
Housing	Plastics / aluminum
Output types	depending on encoder





2D/3D Laser profile sensors

with high accuracy and profile frequency

scanCONTROL

- Compact size with integrated evaluation: no external controller required
- High profile resolution for the detection of finest details
- High profile rate for dynamic measurement tasks
- Powerful software for parameterization and visualization
- SDKs for integration in individual software environments
- SMART design with integrated evaluation



Laser scanners from Micro-Epsilon are among the highest performing profile sensors with respect to accuracy and measuring rate. They detect, measure and evaluate profiles on different object surfaces without contact. The available models are suitable for numerous industrial applications. The integrated intelligence in their sensor head (scanCONTROL SMART) solves versatile measurement tasks. Models for the customer's own programming are available for system integrators. scanCONTROL profile scanners do not require any external controller, which considerably simplifies the installation effort.

Equipped with powerful processors and highly sensitive optical components, these scanners ensure precise profile measurements on almost any type of surface. While they can be integrated in numerous environments, the laser scanners also impress with their compact design which includes an integrated controller.

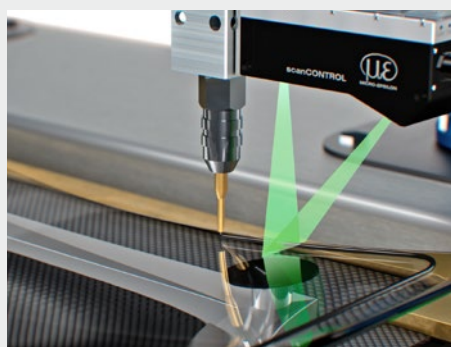

In-line inspection of adhesive bonding



Gap and flushness measurement on bodywork parts

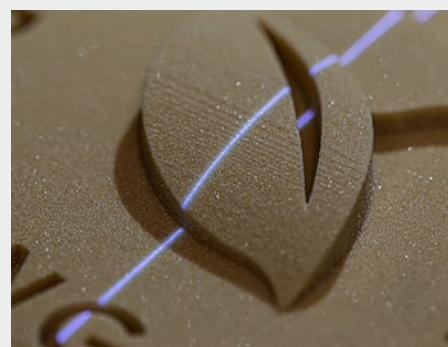

Quality inspection with 3D printing



scanCONTROL 25xx
Laser scanner for serial applications

Measuring range	z-axis	up to 265 mm
	x-axis	up to 143.5 mm
Resolution	x-axis	640 points/profile
Profile frequency		up to 2,000 Hz



scanCONTROL 29xx
Laser scanner with high precision

Measuring range	z-axis	up to 265 mm
	x-axis	up to 143.5 mm
Resolution	x-axis	1,280 points/profile
Profile frequency		up to 2,000 Hz



scanCONTROL 30xx
High-performance laser scanner

Measuring range	z-axis	up to 600 mm
	x-axis	up to 788 mm
Resolution	x-axis	up to 2,048 points/profile
Profile frequency		up to 10,000 Hz



scanCONTROL 8x00
High-performance laser scanner with green laser

Measuring range	z-axis	up to 95 mm
	x-axis	up to 115 mm
Resolution	x-axis	up to 4,224 points/profile
Profile frequency		up to 10,000 Hz

NEW 3D Profile Unit
Automated inline 3D inspection and 2D profile evaluation

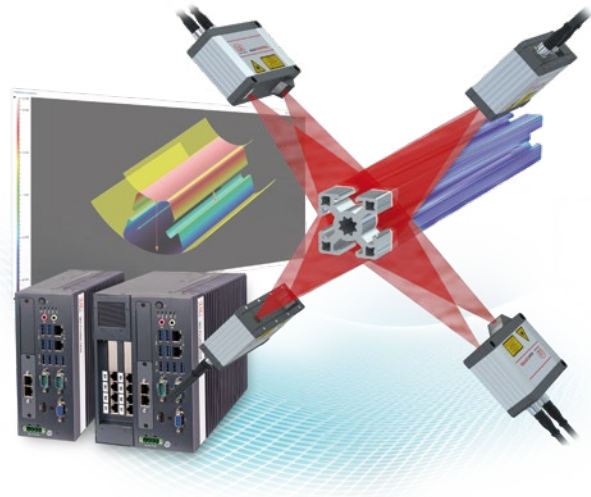

3DInspect – powerful software for scanCONTROL

- Easy sensor configuration
- Point cloud alignment and filtering
- Intuitive detection and selection of relevant areas
- Valid3D: real 3D point clouds instead of 2.5D analysis

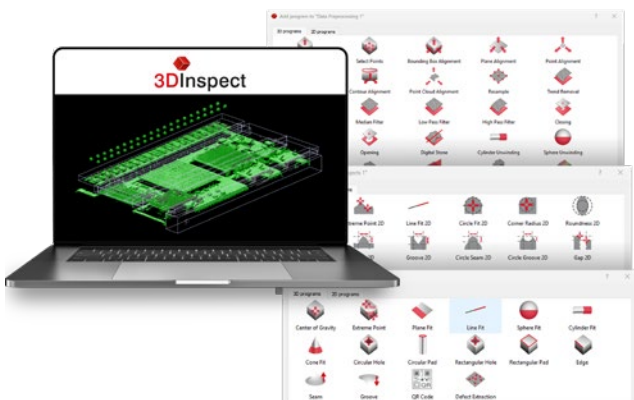

scanCONTROL Software integration

- Ethernet GigE Vision
- SDK for fast integration in C/C++ (Linux and Windows) or C# (Windows) applications
- Example VIs for NI LabVIEW for integration using LLT.DLL or NI IMAQdx

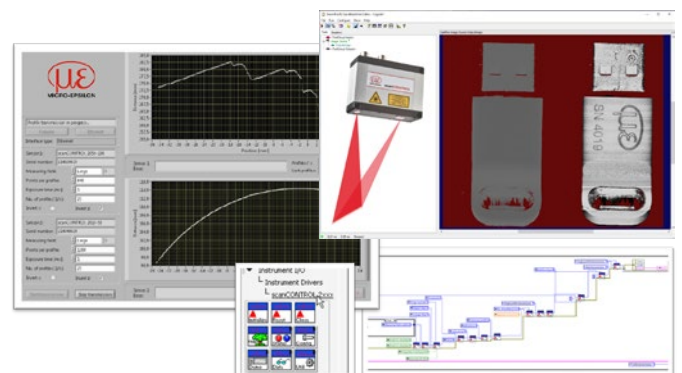

Optical micrometers & fiber optic sensors

optoCONTROL

- Various models for different applications
- Large working distance
- Compact designs with integrated controller
- High accuracy
- Large measuring ranges up to 95 mm
- Detection of edges, gaps, positions and diameters of round objects
- Inspection and detection of position and presence



Optical micrometers are primarily used for production control and quality monitoring, and continuously measure both endless material and single parts. The technologies used are suitable for a wide range of applications. The compact optoCONTROL models are suitable for applications in production lines, as well as for integration in testing machines and automated production systems. The high measuring rates ensure a high and continuous cycle rate in the production process.

All optoCONTROL models work without rotating mirrors and are therefore completely wear-free. The parallel light curtain is created by special optics in the light source. High quality components in the receiving optics, e.g. filters and lenses, enable the high accuracy of the micrometers. This is why optoCONTROL micrometers are particularly suitable for fields where high precision and reliability are required.



Diameter measurement at conical constrictions



Inline contour measurement of turned parts



Diameter measurement of extruded products

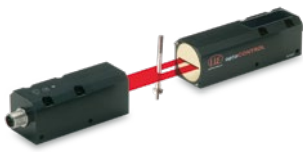

optoCONTROL 1200
Compact high-speed micrometer (laser)

Measuring ranges (mm)	2 5 10 16 20 30
Linearity	±40 µm (independent)
Resolution	10 µm
Frequency response	100 kHz
Integrated controller	



optoCONTROL 2520
Compact laser micrometer (class 1M)

Measuring range (mm)	46 95
Linearity	±12 µm
Resolution	1 µm
Measuring rate	2.5 kHz
Integrated controller	Operation via web interface

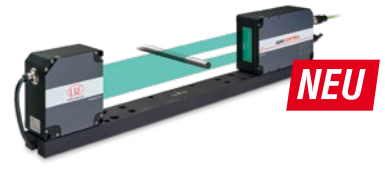

optoCONTROL 2700
High-performance micrometer for the highest demands

Measuring range (mm)	10 40
Linearity	≤ 0.5 µm
Resolution	10 nm
Measuring rate	15 kHz
Integrated controller	Operation via web interface



profileGAUGE C.ODC
Measuring system for two-axis measurement of profile, thickness and position

Plug-and-play solution: pre-assembled, aligned, and wired
Ideal for tubes and thin objects, e.g., wire

Angle measurement and active inclination correction of the measured object

Versatile fieldbus connectivity for maximum flexibility: Ethernet / EtherCAT / RS422 / EtherNet/IP / PROFINET

Optimized for inline quality control at high process speeds

optoCONTROL CLS1000
Fiber optic sensor for industrial applications

- Extremely robust and compact
- Numerous fiber optic sensors
- Large detection and operating ranges
- Extremely high resistance to ambient light
- Numerous teach-in modes and output types

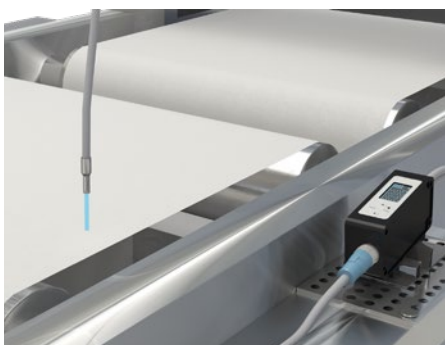
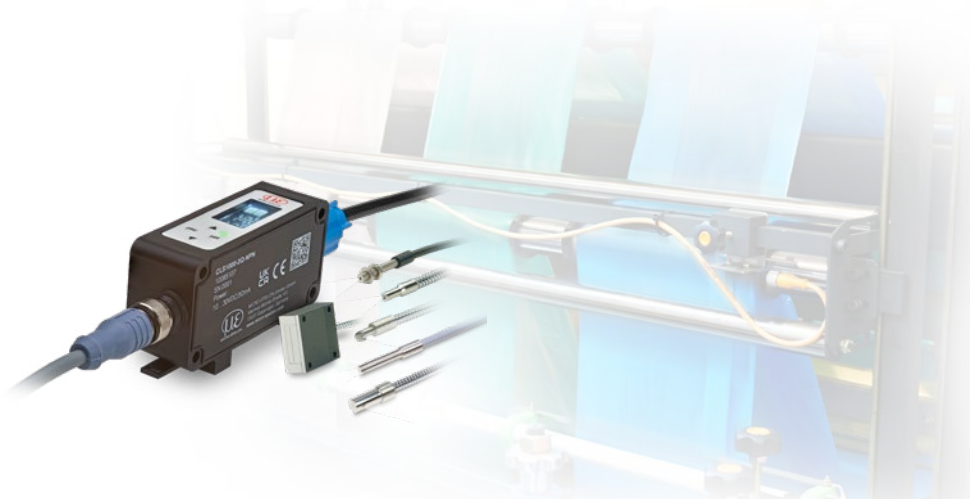

Breakage inspection of belt material

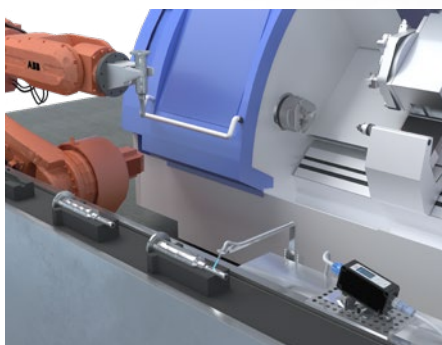

Groove detection on the shaft

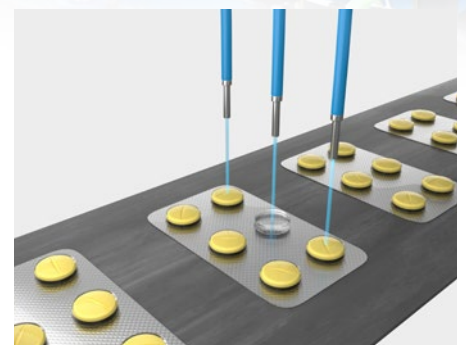

Packaging control of blisters

> High precision 3D measurement & surface inspection



With the surfaceCONTROL, reflectCONTROL and scanCONTROL sensor systems, Micro-Epsilon presents a new generation of 3D sensors which are based on a common software platform. These 3D sensors are used for high-resolution geometry and surface measurements and detect the measuring object by scan or by single snapshot, allowing fast inspection of matt and glossy surfaces. In contrast to conventional 3D systems with 2.5D evaluation, Micro-Epsilon's Valid3D technology enables a complete representation and precise evaluation of the 3D point cloud.

These 3D sensors are used, e.g., for geometric component testing, position determination, presence checks and the measurement of flatness or planarity. Thanks to their high performance, the sensors are used for inline applications, on robots and also for offline inspection.



3D inspection of components



3D shape measurement of wafers

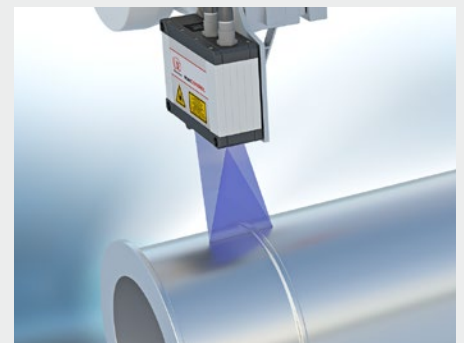

Scan of components before laser cladding

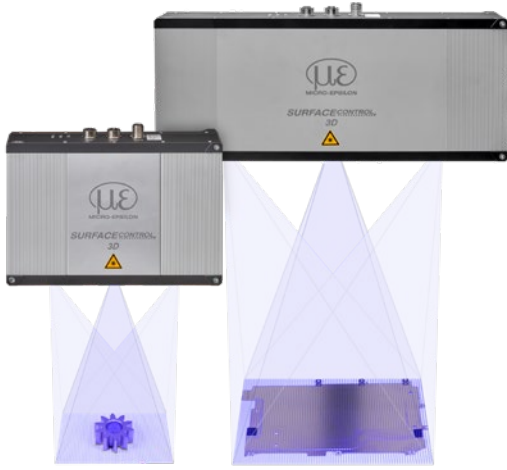

surfaceCONTROL 3D 3200/3500

3D sensor for the inspection of geometry, shape and surfaces
 Highest precision in z up to $< 0.4 \mu\text{m}$
 Complete 3D images from 0.2 s
 Micrometer-accurate snapshots with large measuring fields
NEW Highest resolution in z and xy



surfaceCONTROL 3D 2500

3D inspection of large format surfaces
 Large measuring fields
 Detecting surface shape defects
 Detection and evaluation of 3D surface data within a few seconds



reflectCONTROL SENSOR

Complete inspection of reflecting and shiny surfaces
 Highest z-accuracy $< 1 \mu\text{m}$
 Detection and evaluation of 3D surface data within a few seconds



reflectCONTROL Automotive

Fully automatic surface inspection of painted car bodies
 Ideal for large-surface and curved objects
 Recognition of defects, inclusions, craters etc.



scanCONTROL 3D

Precise laser line scanners for 3D point clouds
 Red laser & patented Blue Laser Technology
 Up to 2048 points per profile
 Measuring rates up to 10,000 Hz
 One design for all measuring ranges



The powerful solution for 3D measurement tasks

The Industrial Performance Unit (IPU) is a powerful computing platform for the efficient commissioning of Micro-Epsilon 3D sensors. The 3DInspect software enables the parameter setting of the sensors and the point cloud evaluation. High compatibility to image processing environments is ensured via the GenICam standard.

Precise color sensors, color measuring systems & LED Analyzers

colorSENSOR / colorCONTROL

- Non-contact color measurement for industrial applications
- Precise and fast measurements even on poorly reflecting surfaces
- Numerous sensors for all tasks
- Measurement accuracies ΔE up to 0.08
- Measurement frequencies up to 30 kHz
- Intuitive operation and configuration
- Ethernet and RS232 process interfaces



Color sensors from Micro-Epsilon are used for precise color measurements and color recognition. The sensors measure color values, intensities and functions on different surfaces. As a result, they are used in a variety of applications and stand for high productivity and cost reduction in manufacturing, automation and quality assurance.

colorSENSOR and colorCONTROL sensors are used for numerous measurement tasks. In addition to print mark recognition or batch testing, the sensors are used for measurement tasks that cannot be solved with other measurement processes. For example, the sensors check the presence of transparent coatings or determine the orientation of bottles based on an embossing mark. The MFA LED Analyzer also checks the function, color and intensity of LEDs, lamps or light sources. Thanks to the high accuracy and measuring rate, the range of applications is extremely diverse and can be found in numerous industries.

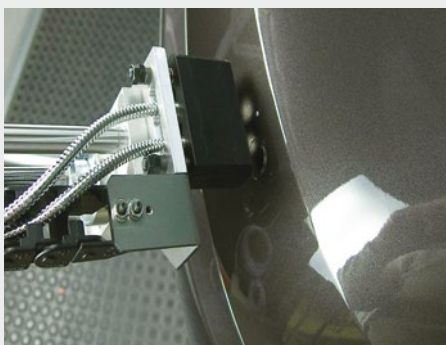

Checking the identical coloring of attachments in automotive production



Inspection of the interior coating in aluminum cans



Sorting of plastic components (connector colors)



colorSENSOR CFO

Precise True Color Sensors for industry and automation

Repeatability $\Delta E \leq 0.3$

Measurement speed max. 30 kHz

Color memory 320 colors in 254 color groups

Numerous sensors for all surfaces

NEW colorSENSOR CFO250 for fast output of measurement values



CFS sensors

with integrated optical glass fibers for adaptation to colorSENSOR CFO controller

Ambient temperature -40 ... 400 °C

Working distance 5 ... 320 mm

Measurement spot diameter 0.8 ... 70 mm



colorSENSOR OT-3-LD

Color sensors with fixed lens for large measurement distances

Repeatability $\Delta E \leq 0.9$

Switching frequency max. 35 kHz

Color recognition from a large distance up to 900 m



colorCONTROL MFA

Sensor system for LED tests

Color distinction, intensity tests & function tests of LEDs

Available with either 7, 14, 21 or 28 measurement channels



colorCONTROL ACS7000

Inline color measuring system for non-contact color measurements

Measurement geometries Transmission sensor, circular sensor, 30°/0° sensor

Repeatability $\Delta E \leq 0.08$

Spectral measuring range 390 ... 780 nm

Measuring rate 2 kHz

Color recognition from a taught reference list

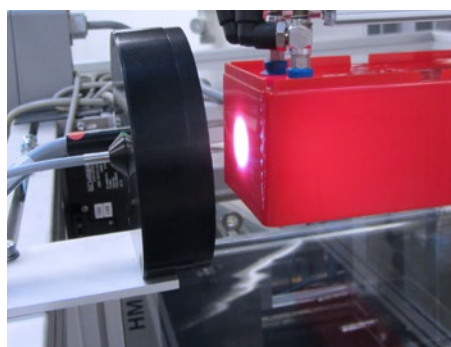

Inline color measurement of plastic injection-molded parts directly after demolding



Inline color gradient measurement of transparent film and acrylic glasses

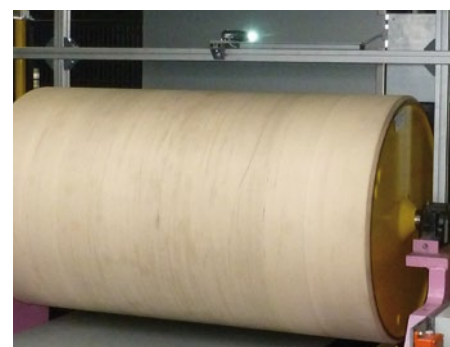

Color measurement of continuous strip coating such as aluminum, zinc and paper during production

Non-contact infrared pyrometers

for industrial measurement tasks

thermoMETER

- Infrared pyrometer for non-contact temperature measurement
- Temperature ranges from -50 °C to +1100 °C
- Compact design
- Perfect signal stability and signal quality
- Perfectly customizable for OEM
- Robust, wear-free and reliable
- Various integration possibilities



Analog

RS485

Ethernet

PROFINET

EtherNet/IP

EtherCAT

Precise temperature measurement in industrial applications

Infrared pyrometers from Micro-Epsilon are designed for measuring surface temperatures from -50 °C to 1100 °C. The infrared radiation emitted by a body is used for the measurement. As this measurement is non-contact, the devices perform wear-free and can therefore be reliably used over long periods of time. Selectable models and optical systems enable the installation in different distances from the surface. This allows for the target to be measured from a safe distance in critical applications.

Wide range of use in industrial applications

Infrared pyrometers are used in a variety of applications for non-contact temperature measurement: from factory automation, R&D to maintenance, process monitoring and machine building. Their flexibility, combined with high measurement accuracy and durability, makes them the first choice when it comes to non-contact temperature measurement in a wide range of industries.



Temperature measurement in the coating process of battery films

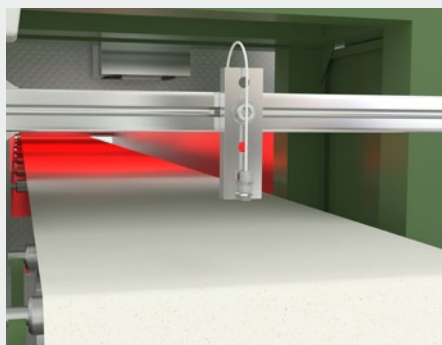

Monitoring the drying process in paper production



Measuring the temperature of samples in DNA analyzers



thermoMETER UC

High-performance industrial pyrometer

Temperature measuring range from -50 to +1000 °C

High temperature resolution of 50 mK

Analog and digital interfaces

Powerful alarm relays with 400 mA

No cooling required for ambient temperatures up to 180 °C

Powerful industrial controller



thermoMETER SE

Robust miniature pyrometer

Temperature measuring range from -40 to +1100 °C

Short response time of 20 ms

Voltage or two-wire current output (switchable via software)

Open-collector output with 500 mA

No cooling required for ambient temperatures up to 120 °C

Ideal for OEM series applications



thermoMETER FI

Fully integrated compact pyrometer

Temperature measuring range from -40 to +1100 °C

Short response time of 20 ms

Freely scalable voltage output

Open-collector output with 200 mA

No cooling required for ambient temperatures up to 80 °C

Ideal for OEM series applications

Compact sensor and controller designs

At just 12 or 14 mm in diameter, these cylindrical sensors are extremely small and can therefore be integrated into even the tightest installation spaces. Installation is quick and easy due to the M12 thread embedded in the housing. Depending on the application, the controller can be integrated in the sensor or remote.



Extensive software features for parameterization and evaluation

The thermoMETER series is equipped with the free sensorTOOL display and parameterization software.

This digital interface allows for the sensors to be parameterized for specific applications. In addition, you can display, save and export measurement data.



Pyrometers for special applications

Special pyrometers are available for special applications. The models are suitable for fast measurements, high ambient temperatures and temperature measurement on hot metals.



Innovative sensor technology

for specific applications



As well as standard sensors based on various measuring principles, Micro-Epsilon has developed numerous sensors for special applications, which go beyond pure displacement and position measurements.

These application-specific sensors were developed for special measurement tasks and have proven themselves there many times. These developments incorporate the many years of know-how that Micro-Epsilon has accumulated in the design and application of sensor technology. High performance, precision and reliability at cost-effective OEM conditions are the main focus.



Rotational speed measurement of turbochargers



Measuring the thermal extension of spindles

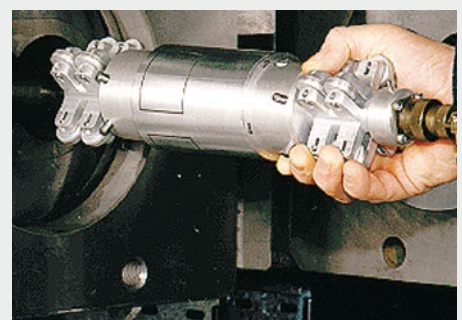

Inspection of the inner diameter of extruder housings



SGS Spindle Growth System

Sensor system developed for measuring the thermal extension of milling spindles

Measuring range 500 μm

Resolution 0.5 μm

High temperature range



idiamCONTROL

Non-contact inspection of extruder bores

Non-contact and wear-free measurement technique for all metals without calibration

Exact, non-destructive inspection



DZ140

Sensor for rotational speed measurement during driving operations and tests

Optimized for modern, thin blades made from aluminum or titanium

Speed range from 200 to 400,000 rpm

Wide operating temperature range

Large distance between sensor & blade

No rotor modification required



combiSENSOR

One-side thickness measurement of plastic films and coatings

Thickness of the target	5 μm to max. 6 mm
Working distance	2 to 10 mm
Resolution	0.0018 % FSO
Frequency response	1 kHz (-3dB)



capaNCDT TFG6220

Fast offline thickness measurement of thin film

Possible film thickness	< 1 mm
Repeatability	1 μm
Resolution	10 nm



Inline yarn thickness measurement



Load detection in washing machines

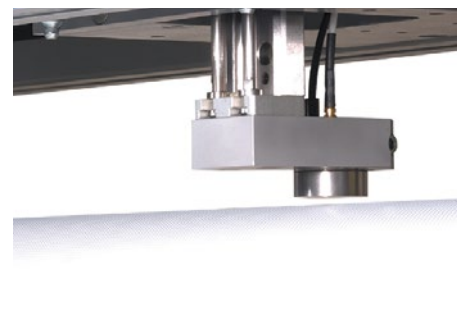

Non-contact, inline thickness measurement of plastic films

Sensor systems

for precise thickness measurement and 3D evaluation

thicknessGAUGE

- Compact complete solution for precise inline thickness measurements
- For many types of surfaces and materials due to different sensor technologies
- Traverses via linear axis
- Fully automatic calibration
- 24 V supply for the entire system
- Integrated software



Sensor system for precise thickness measurement of strip and plate materials

thicknessGAUGE sensor systems are used for precise thickness measurements of strip materials, plates and sheets up to 50 mm. Several models with different sensor types, measuring ranges and measuring widths enable inline thickness measurements of different materials and surfaces based on an unmatched price/performance ratio.

This fully assembled system comprises a stable frame on which two optical distance sensors are fixed, that detect the thickness of the measuring object according to the difference principle. The sensors are perfectly aligned to each other and calibrated at the factory. A linear axis moves the sensor system from the parking position to the measuring position. The measurement standard for fully automatic calibration is located in the parking position to ensure uninterrupted operation.



Thickness measurement of metal film, metal strips and plates



Thickness measurement of fuel cells and battery film (coated and uncoated)



Thickness measurement of plastic film and plates, woven materials, wood and ceramics

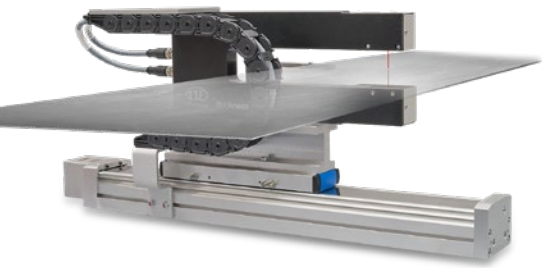

thicknessGAUGE C-frame systems

Sensor system for precise inline thickness measurements

For many types of surfaces / materials due to different sensor technologies

Traverses via linear axis

Fully automatic calibration

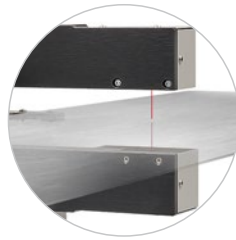

thicknessGAUGE C.LL
Sensor technology used:
Laser triangulation displacement sensors

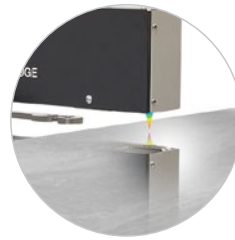

thicknessGAUGE C.C
Sensors used:
Confocal chromatic displacement sensors



thicknessGAUGE C.LP
Sensors used:
Laser profile sensors



thicknessGAUGE O-frame systems

Sensor system for precise thickness measurement of strip and plate material

Compact complete solution for inline thickness measurements

Different material widths up to 1,250 mm

Traversing measurement or fixed track measurement



thicknessGAUGE O.EC
Sensors used:
combiSENSOR

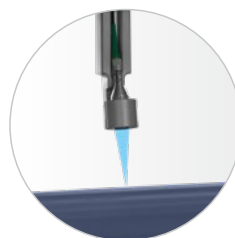

thicknessGAUGE O.IMS
Sensors used:
White light interferometer

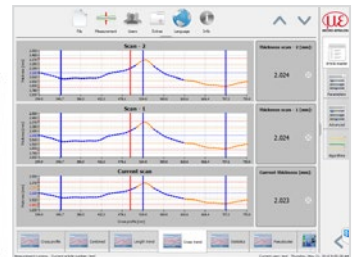

NEW

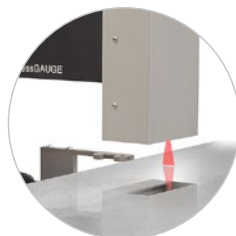

thicknessGAUGE 3D
Sensors used:
Laser profile sensors with red laser

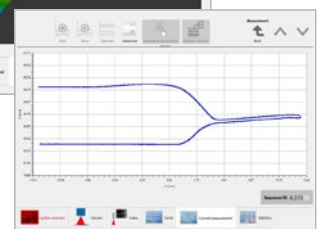
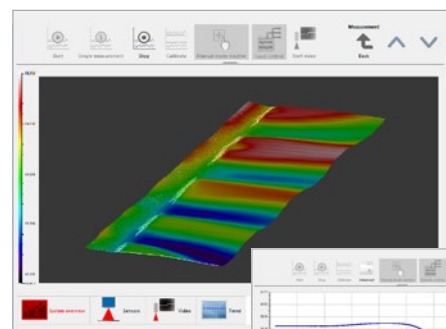

thicknessGAUGE 3D

Sensor system for precise thickness and 3D profile measurement

Compact complete solution with 24 V supply

Measurement of numerous surfaces / materials

Traverses via linear axis

Integrated software

Fully automatic calibration



Measuring and inspection systems

for steel, aluminum, plastic and rubber



Measuring and testing systems from Micro-Epsilon combine sensors, software and mechanics in an integrated overall solution. The systems are used for process monitoring and quality assurance in the production line and impress with high precision and ease of integration. The sensor and software modules used originate from the Micro-Epsilon group, enabling optimum and efficient component matching.

These measuring and inspection systems are integrated into existing or newly designed production lines to carry out fully automatic applications such as thickness measurements, surface inspections and parts classification. The systems are used, for example, in metal rolling mills, battery production, the plastics industry, and in the manufacture of tires and technical rubber.

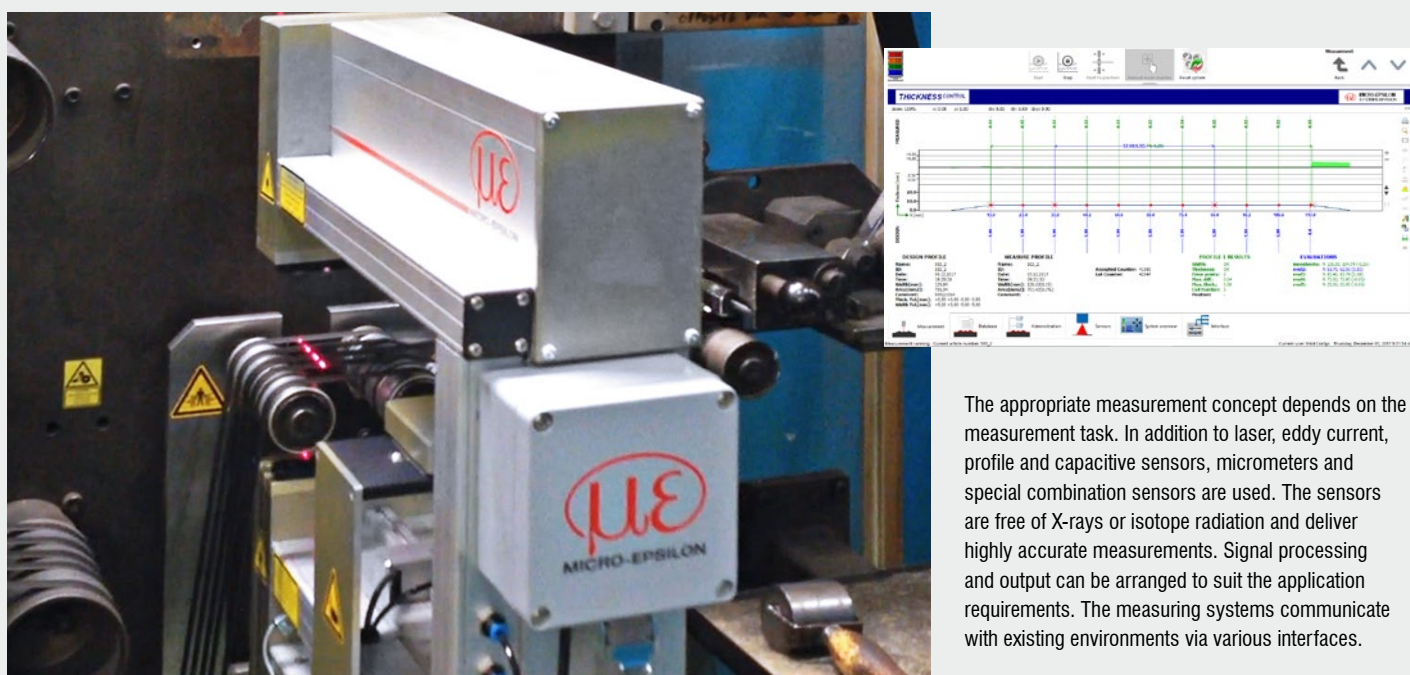

The appropriate measurement concept depends on the measurement task. In addition to laser, eddy current, profile and capacitive sensors, micrometers and special combination sensors are used. The sensors are free of X-rays or isotope radiation and deliver highly accurate measurements. Signal processing and output can be arranged to suit the application requirements. The measuring systems communicate with existing environments via various interfaces.



Systems for metal thickness measurements

For fast and precise measurements on all alloys

Laser sensor technology without isotopes and X-rays

Reliable measurement independent from belt movements, tilt and surface

For cold rolling mills and hot rolling mills



Inspection and production systems for the tire industry

Systems for the preparation area

Systems for curing

Systems for final inspection



Systems for plastics testing

C-frames for thickness measurement of flat film

O-frame systems for profile thickness measurement

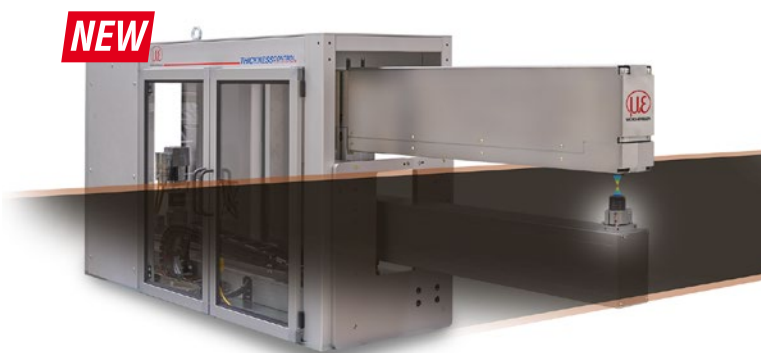

Measuring systems for battery production

High precision thickness measuring system for coated anode and cathode films

Quad measuring system consisting of two robust measuring frames, each containing eight confocal sensors

Robust design with temperature compensation

Measuring range (thickness) <math>< 6\text{ mm}</math>

System accuracy $\pm 0.3\ \mu\text{m}$



MICRO-EPSILON

MICRO-EPSILON Headquarters

Koenigbacher Str. 15 · 94496 Ortenburg / Germany

Tel. +49 (0) 8542 / 168-0 · Fax +49 (0) 8542 / 168-90

info@micro-epsilon.com

www.micro-epsilon.com