

More Precision



optoNCDT ILR1171-125

Fast laser distance sensor for outdoor applications

- Measuring range up to 270 m
- High measuring rate of 40 kHz
- Robust industrial design with IP67 housing
- Easy integration into existing systems
- Measurement on static and dynamic targets



Model	ILR1171-125	
Article number	7112027	
Measuring range ¹⁾	black 10 %	70 m
	gray 40 %	100 m
	white 80 %	125 m
	Reflector film ²⁾	270 m
Start of measuring range	0.2 m ³⁾	
Measuring rate	up to 40 kHz	
Resolution	1 mm	
Linearity	< ±60 mm ⁴⁾	
Repeatability ⁵⁾	< 25 mm	
Temperature stability	≤ 20 ppm / K	
Light source	Semiconductor laser < 1 mW, 905 nm (red)	
Laser class	Class 1 in accordance with DIN EN 60825-1:2014	
Permissible ambient light	50.000 lx	
Supply voltage	10 ... 30 VDC	
Power consumption	< 3 W (24 V)	
Signal input	Trigger	
Digital interface	RS232 / RS422	
Analog output	4 ... 20 mA (16 bit, freely scalable within the measuring range)	
Switching output	Q1 / Q2 (configurable); trigger	
Connector	Supply/signal: M12 12-pin screw/plug connection	
Mounting	Mounting holes	
Temperature range	Storage	-40 ... +70 °C (non-condensing)
	Operation	-40 ... +60 °C (non-condensing)
Shock (DIN EN 60068-2-29)	30 g / 6 ms in 6 directions, 3 shocks each	
Vibration (DIN EN 60068-2-6)	1 g / 10 ... 2000 Hz in 3 axes, 2 cycles each	
Protection class (DIN EN 60529)	IP67	
Material	Aluminum housing	
Weight	approx. 140 g	
Control and indicator elements	2x LEDs for power and signal	
Special features	Measurement-specific operating modes	

¹⁾ Depends on the reflectivity of the target, ambient light interference and atmospheric conditions

²⁾ ILR-RF250 reflector film 250 x 250 mm; art. 7966001

³⁾ 0.5 m measuring with reflector film

⁴⁾ Linearity in the range ≤ 1m and in the range ≥ 70 m ±100 mm

⁵⁾ Repeatability in the range ≤ 1 m and in the range ≥ 70 m ±50 mm



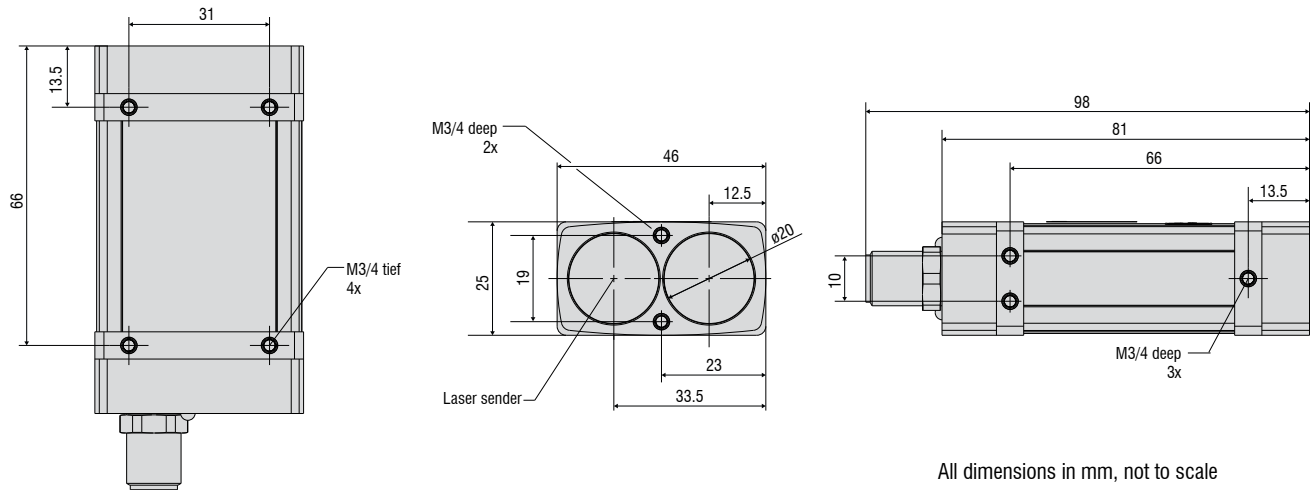

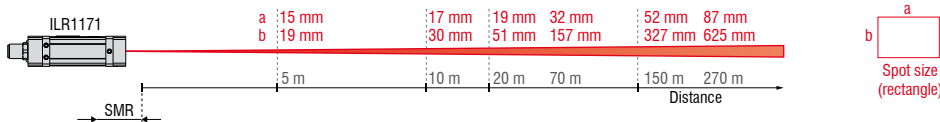

Dimensions



Spot diameter



Accessories

Connection	Interface modules	Connection cables	Sensor	Accessories
Supply/PLC Power supply unit PS2031 Art. no.: 2420096 		Supply and output cable Art. no.: 29011401 (2 m) 29011402 (5 m) 29011403 (10 m) 		Reflector 250 x 250 mm Art. no.: 7966001 
Digital output/Ethernet 	IF2001/USB Art. no.: 2213025  IF1032/ETH Art. no.: 2420066  IC2001/USB Art. no.: 2213041 